

UniPlay Iktaz

1,0m 5,0m

[m]

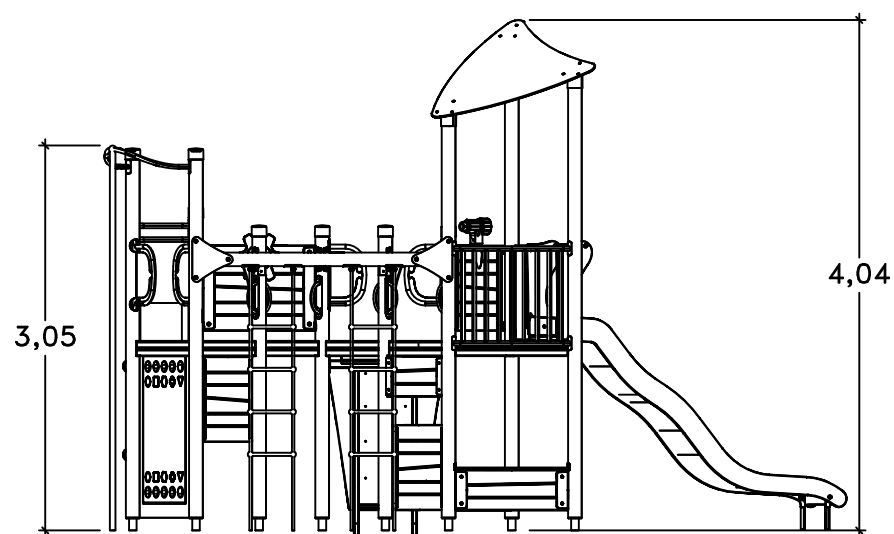
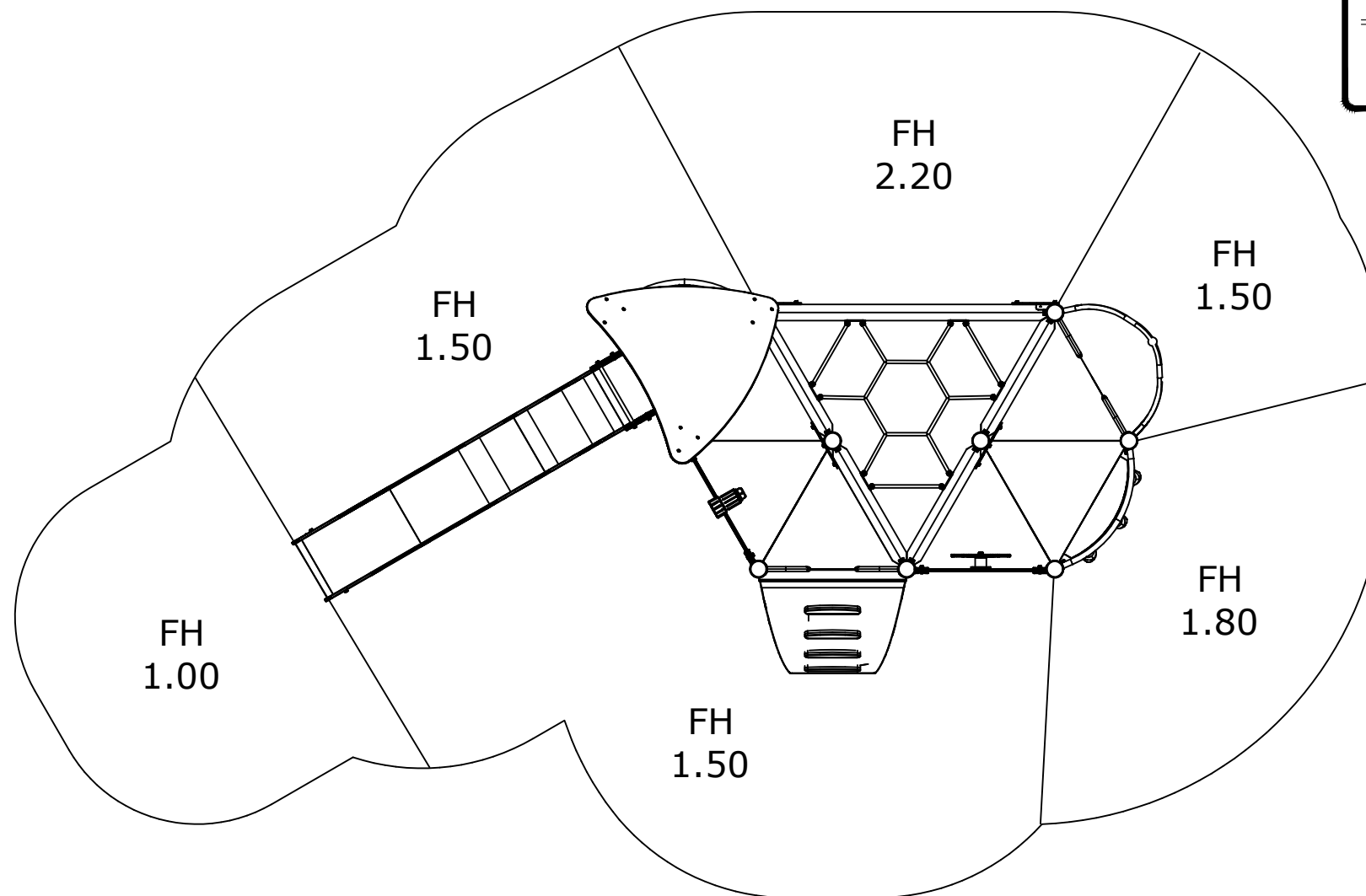
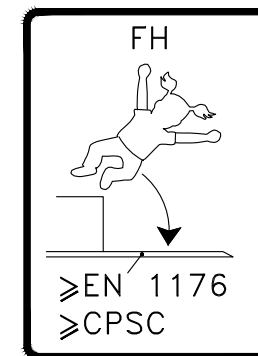
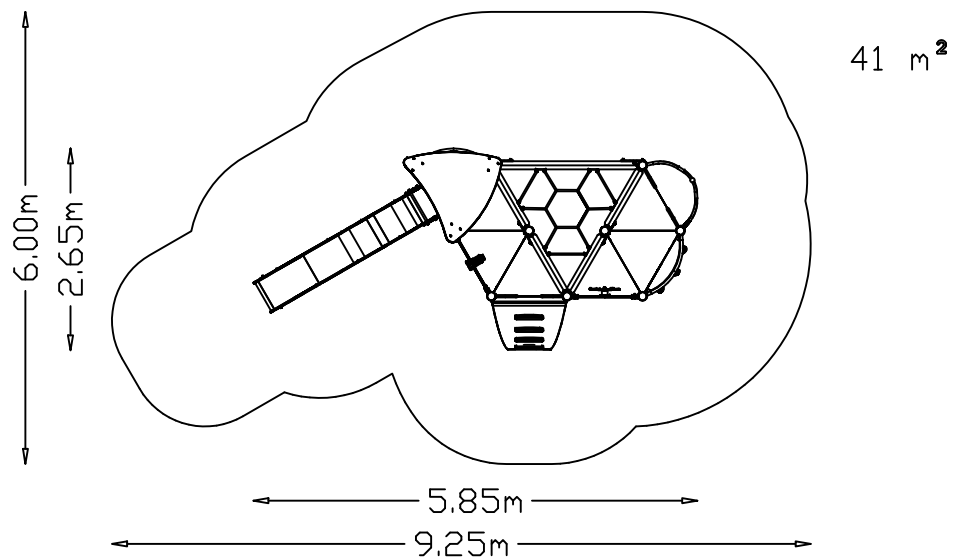

HAGS ANEBY, SWEDEN
+46(0)380-47300
www.hags.com

UniPlay Iktaz
MASW65001
1/9

LN JN 2018-02-14 0



38h



Varje vecka
Every week
Jede woche
Chaque semaine



Varje säsong
Every season
Jedes Jahr
Chaque saison



Step by Step UniPlay

1
2
3
4
5
6
7
8
9
10
11
12
13
14
15
16
17
18
19
20
21
22
23
24
25
26
27
28
29
30
31
32
33
34
35
36
37
38

UNIVERSAL TOOLKIT SUPPLIED WITH:
- 1x Allen key (M5) for the tower
- 1x Allen key (M6) for the tower
- 1x Allen key (M8) for the tower
- 1x Allen key (M10) for the tower
- 1x Allen key (M12) for the tower
- 1x Allen key (M14) for the tower
- 1x Allen key (M16) for the tower
- 1x Allen key (M18) for the tower
- 1x Allen key (M20) for the tower
- 1x Allen key (M22) for the tower
- 1x Allen key (M24) for the tower
- 1x Allen key (M26) for the tower
- 1x Allen key (M28) for the tower
- 1x Allen key (M30) for the tower
- 1x Allen key (M32) for the tower
- 1x Allen key (M34) for the tower
- 1x Allen key (M36) for the tower
- 1x Allen key (M38) for the tower
- 1x Allen key (M40) for the tower
- 1x Allen key (M42) for the tower
- 1x Allen key (M44) for the tower
- 1x Allen key (M46) for the tower
- 1x Allen key (M48) for the tower
- 1x Allen key (M50) for the tower
- 1x Allen key (M52) for the tower
- 1x Allen key (M54) for the tower
- 1x Allen key (M56) for the tower
- 1x Allen key (M58) for the tower
- 1x Allen key (M60) for the tower
- 1x Allen key (M62) for the tower
- 1x Allen key (M64) for the tower
- 1x Allen key (M66) for the tower
- 1x Allen key (M68) for the tower
- 1x Allen key (M70) for the tower
- 1x Allen key (M72) for the tower
- 1x Allen key (M74) for the tower
- 1x Allen key (M76) for the tower
- 1x Allen key (M78) for the tower
- 1x Allen key (M80) for the tower
- 1x Allen key (M82) for the tower
- 1x Allen key (M84) for the tower
- 1x Allen key (M86) for the tower
- 1x Allen key (M88) for the tower
- 1x Allen key (M90) for the tower
- 1x Allen key (M92) for the tower
- 1x Allen key (M94) for the tower
- 1x Allen key (M96) for the tower
- 1x Allen key (M98) for the tower
- 1x Allen key (M100) for the tower

HAGS
UniPlay Iktaz
MASW65001
SE 1(3)
1/9

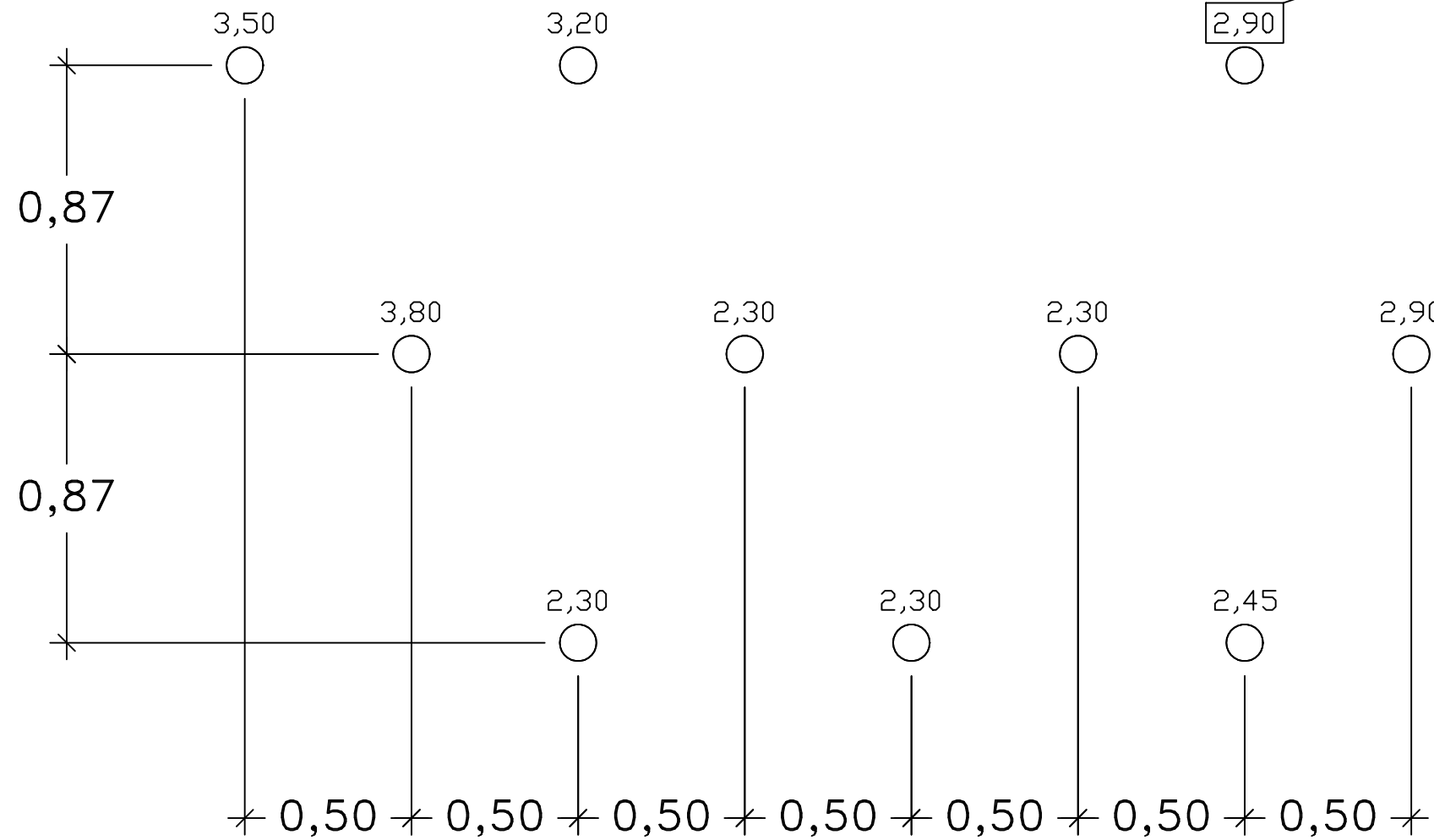
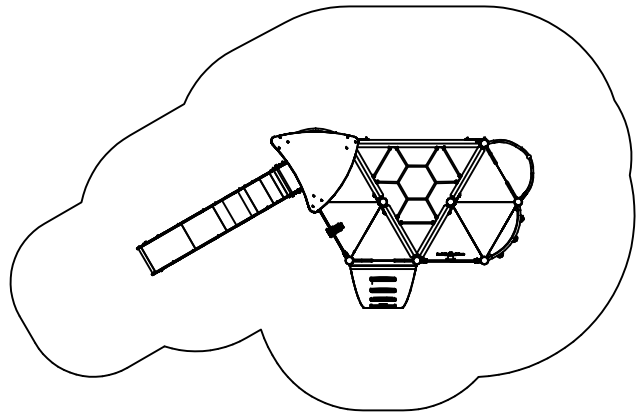

2,90

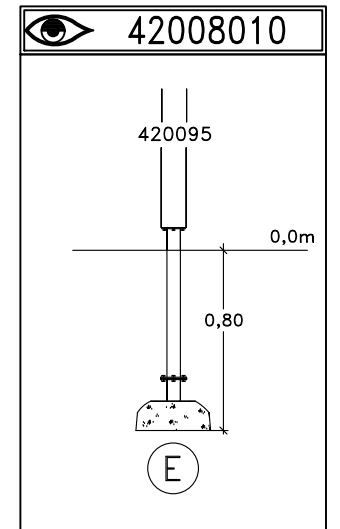
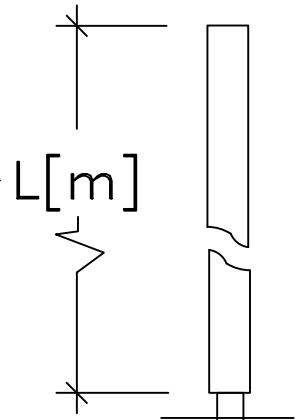

HAGS ANEBY, SWEDEN
+46(0)380-47300
www.hags.com

UniPlay Iktaz
MASW65001
2/9

LN JN 2018-02-14 0

STEP 1

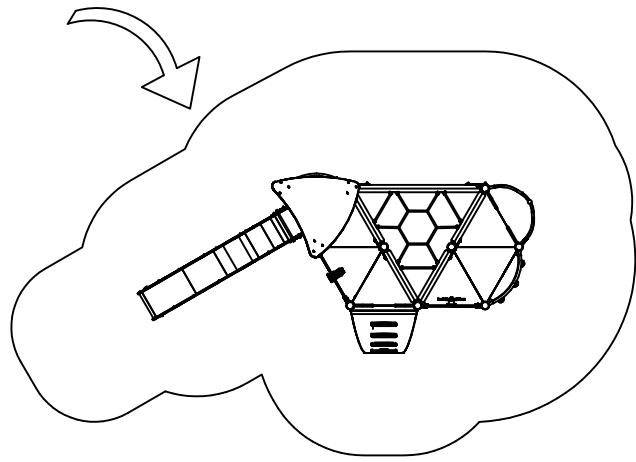

[m]

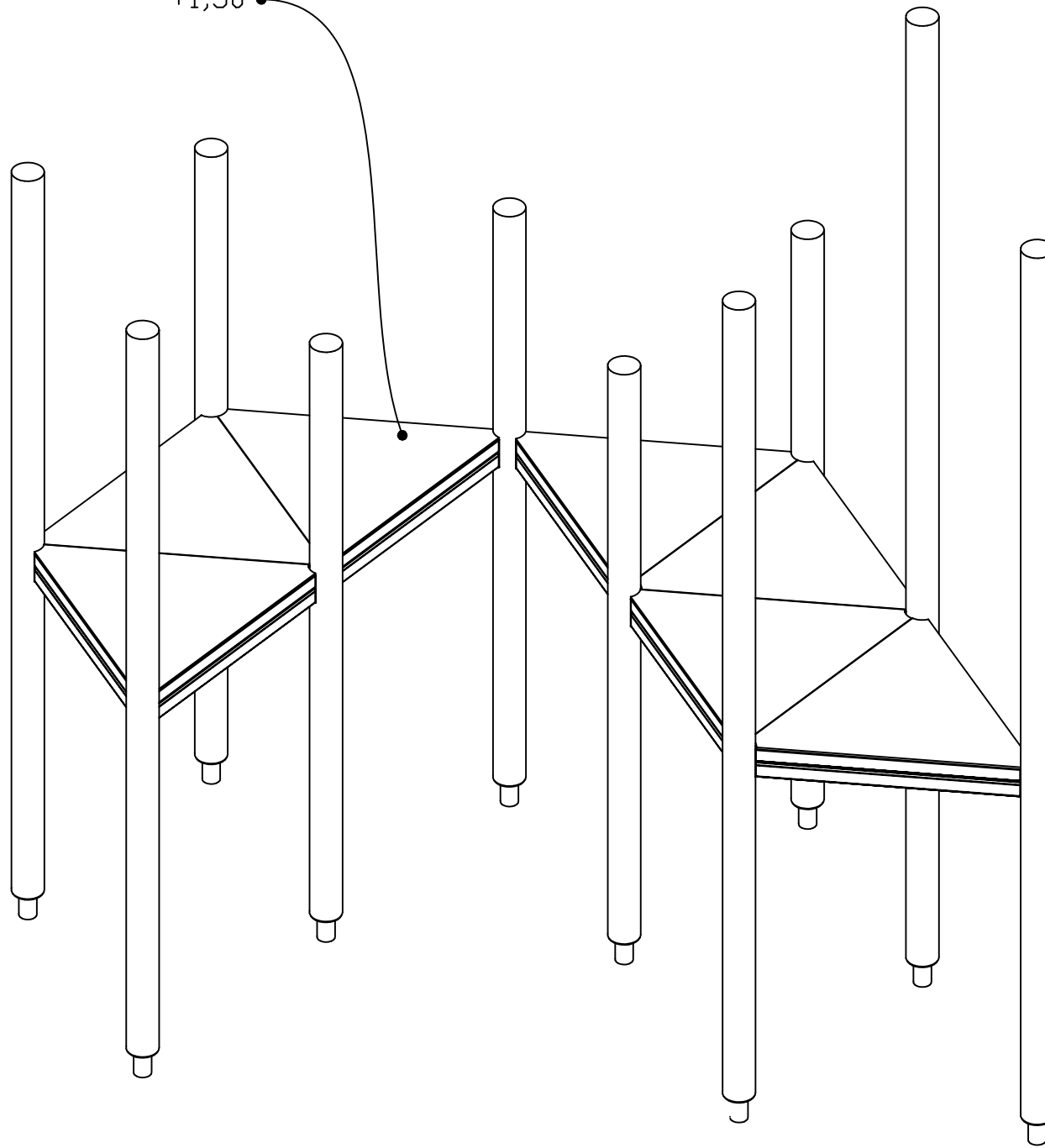

 MASW53811

+1,50



HAGS	ANEBY, SWEDEN +46(0)380-47300 www.hags.com
UniPlay Iktaz MASW65001 3/9	
 LN	 JN 2018-02-14 0

STEP 2

[m]

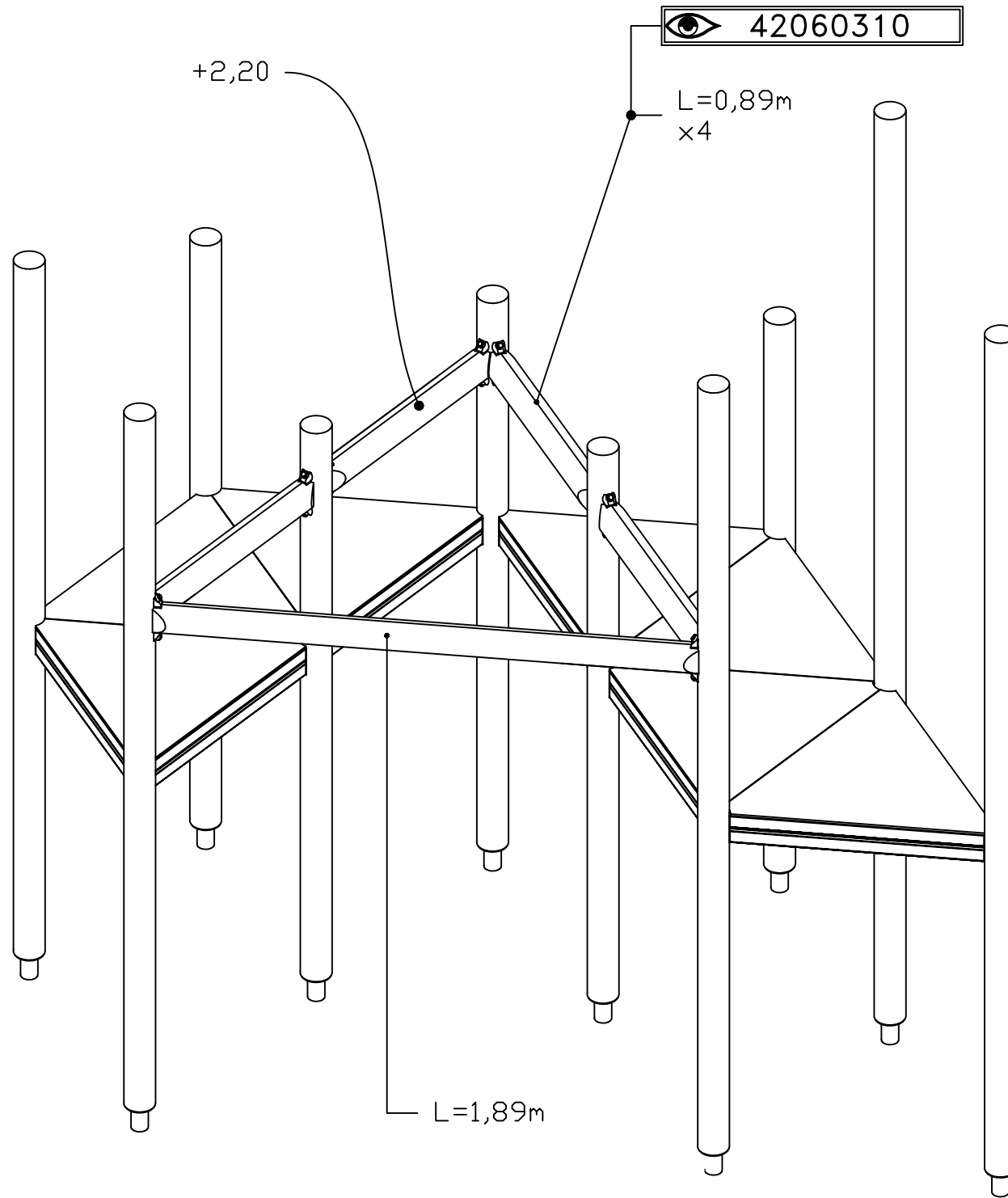
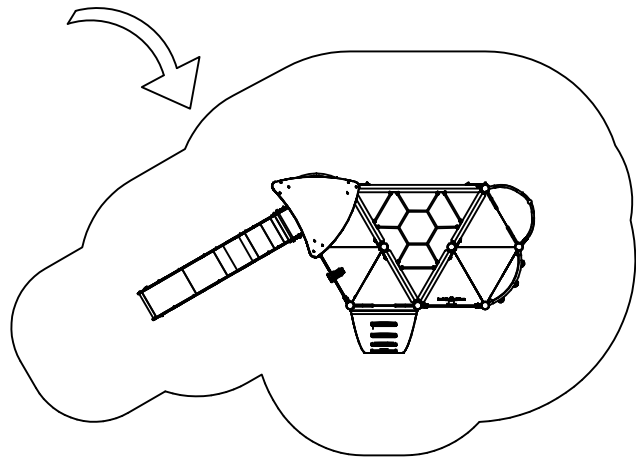

HAGS ANEBY, SWEDEN
+46(0)380-47300
www.hags.com

UniPlay Iktaz
MASW65001
4/9

LN JN 2018-02-14 0

STEP 3

[m]

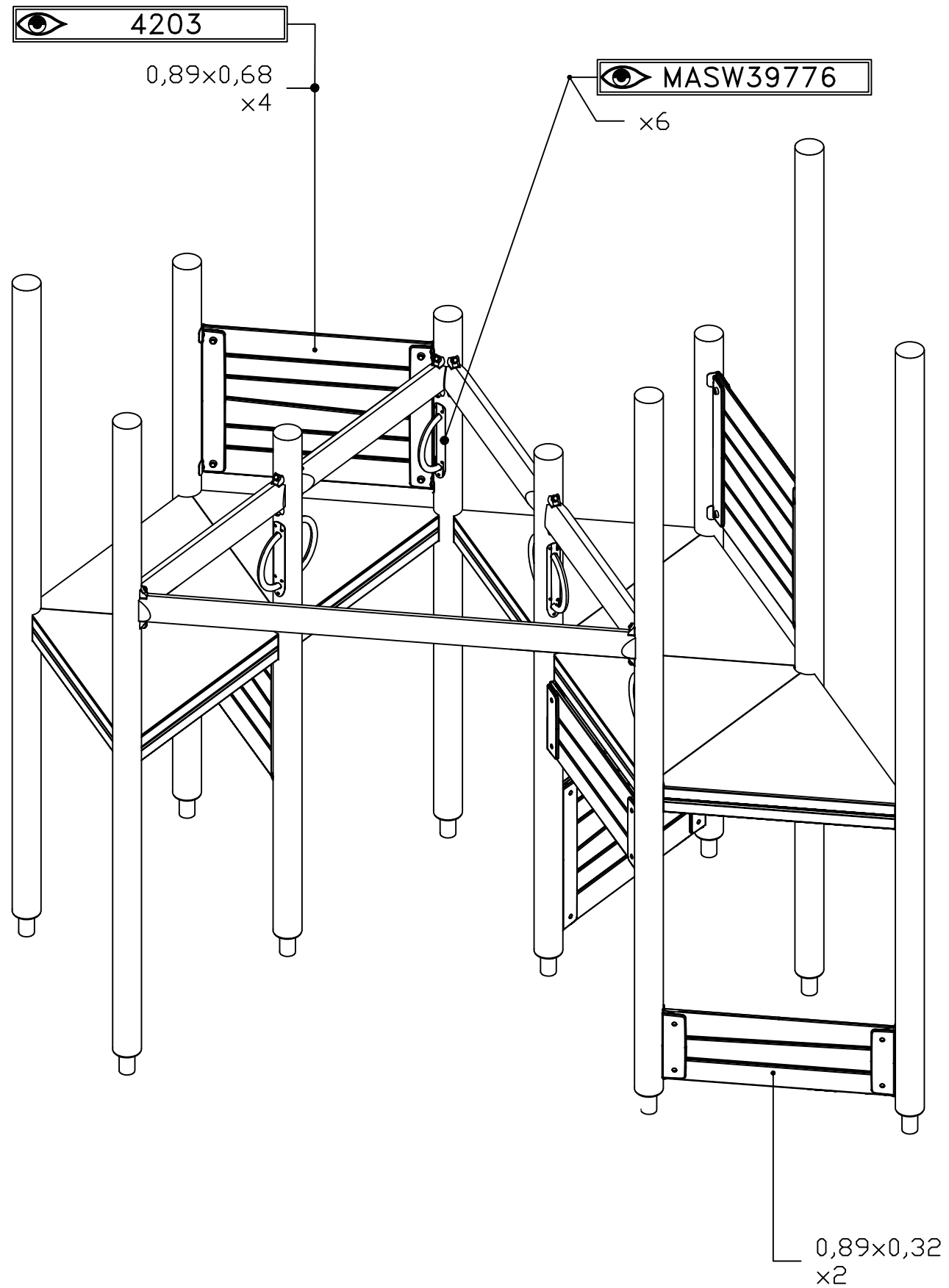
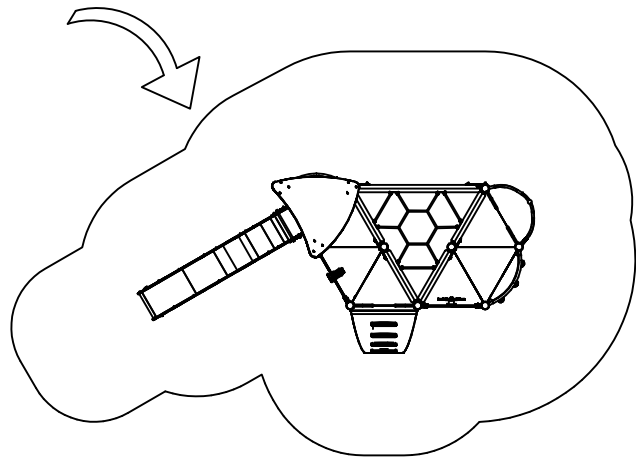

HAGS ANEBY, SWEDEN
+46(0)380-47300
www.hags.com

UniPlay Iktaz
MASW65001
5/9

LN JN 2018-02-14 0

STEP 4

[m]

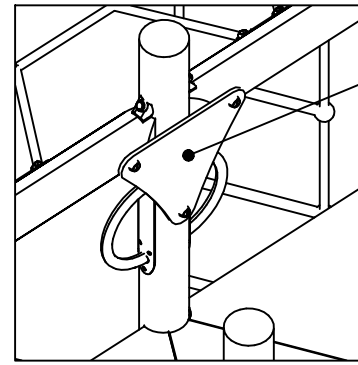
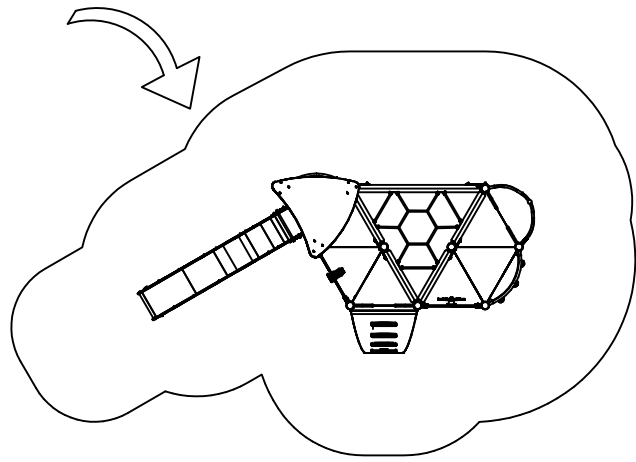

42060742

x2

MASW36304

180°

42060740

x2

42472110

x2

HAGS ANEBY, SWEDEN
+46(0)380-47300
www.hags.com

UniPlay Iktaz
MASW65001
6/9

LN JN 2018-02-14 0

STEP 5

[m]

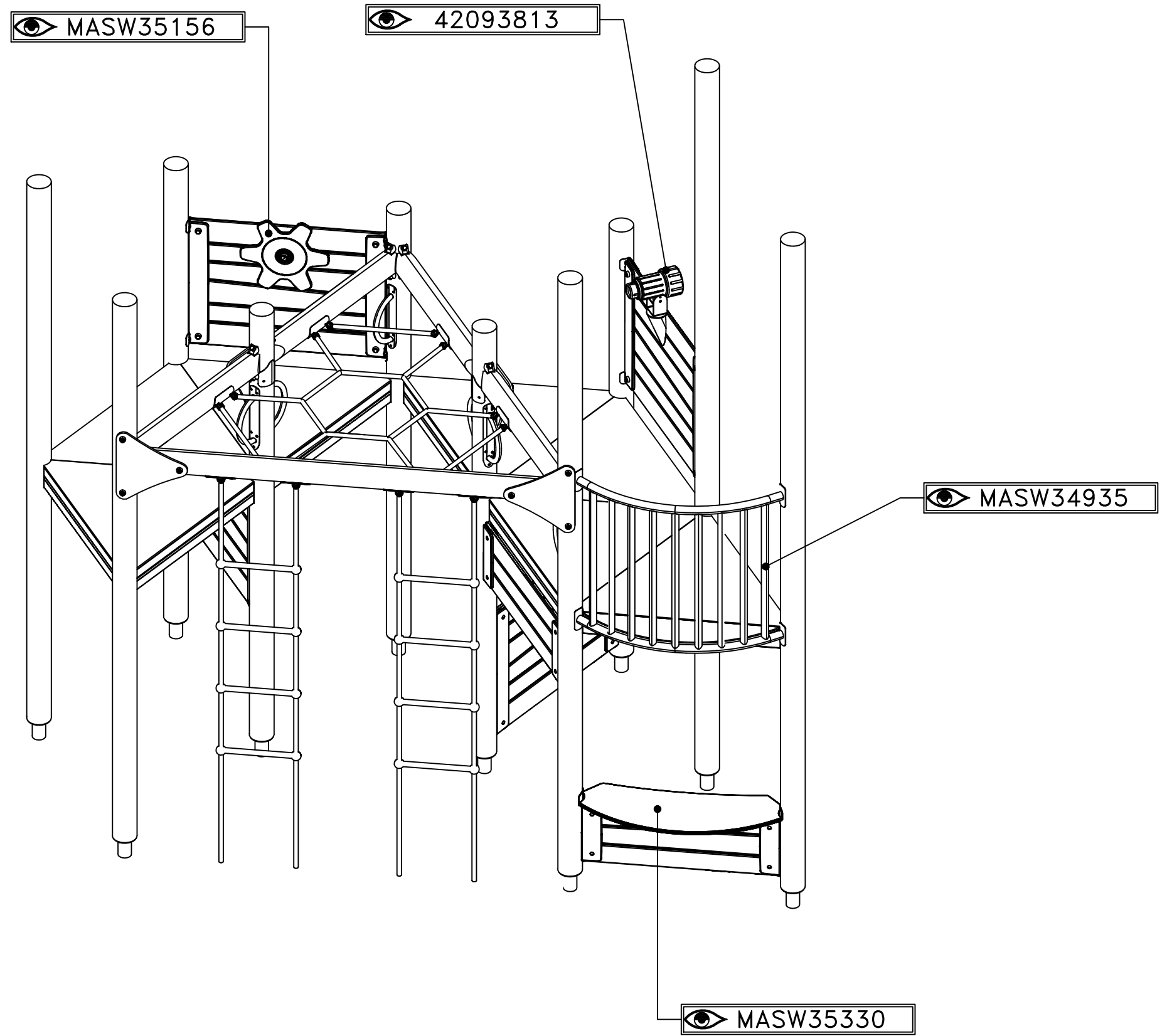
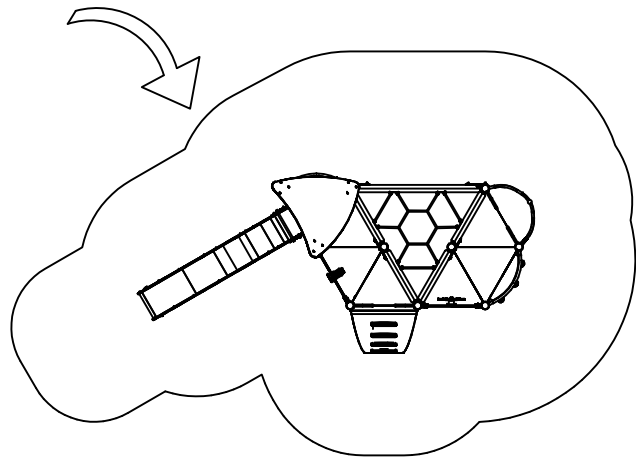

HAGS ANEBY, SWEDEN
+46(0)380-47300
www.hags.com

UniPlay Iktaz
MASW65001
7/9

LN JN 2018-02-14 0

STEP 6

[m]

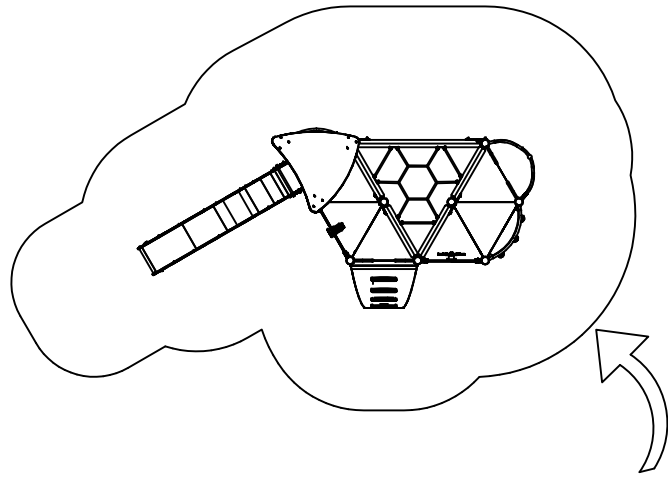

👁 MASW42199

BM

👁 42477010

👁 MASW39686

HAGS	ANEBY, SWEDEN +46(0)380-47300 www.hags.com
UniPlay Iktaz MASW65001 8/9	
🏠 LN	🔍 👁 JN 2018-02-14 0

STEP 7

[m]

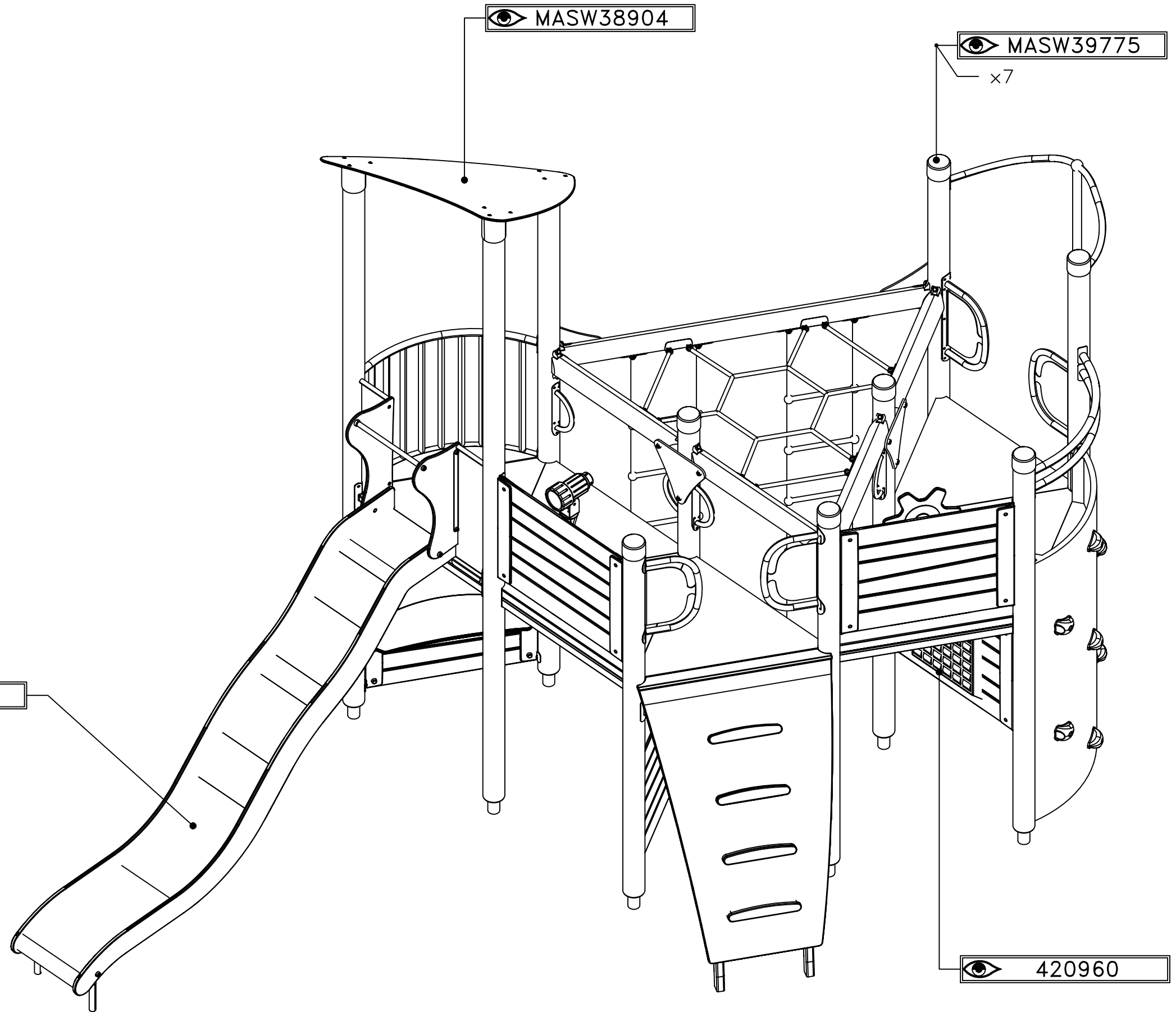
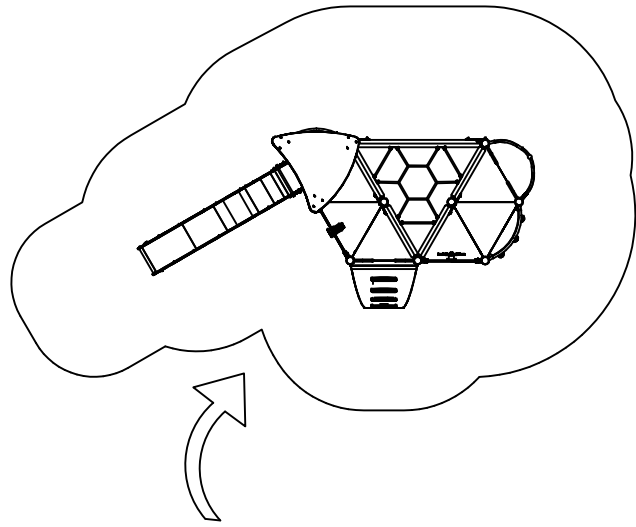

HAGS	ANEBY, SWEDEN +46(0)380-47300 www.hags.com		
UniPlay Iktaz MASW65001 9/9			
LN	JN	2018-02-14	0